

CompX[®]
CHICAGO

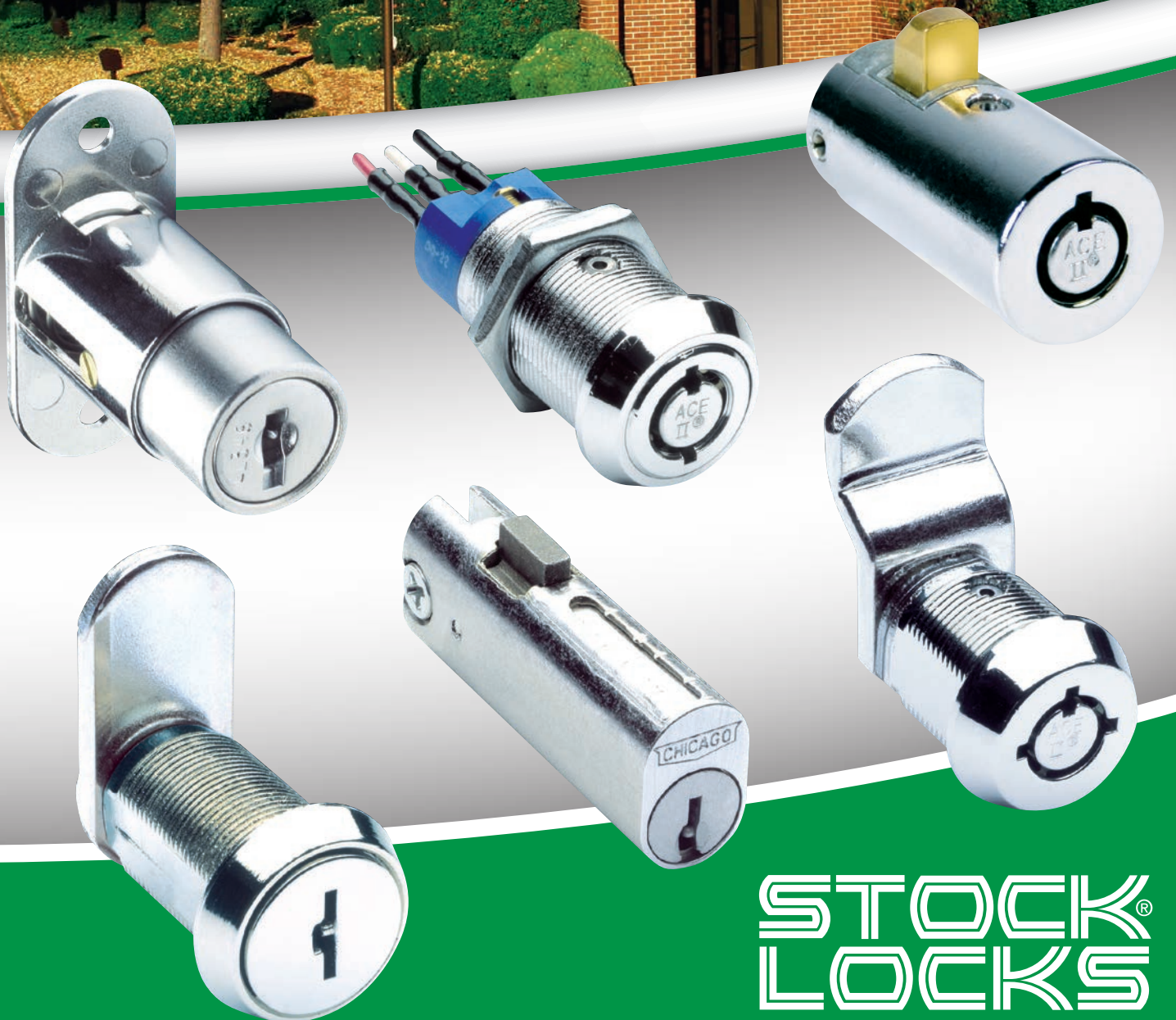

STOCK[®]
LOCKS
Standard Locks for Special Needs

STOCK[®] LOCKS

Through your CompX Chicago distributor . . . a program to meet your lock requirements.

CompX Chicago manufactures a wide variety of locks for residential, commercial and industrial use. We've been solving security problems since the need for metal cabinet locks brought about the founding of our company in 1920.

The locks shown in this catalog are particularly well-suited to serve the replacement market...as well as component manufacturers.

Our experience in serving this market has shown us the importance of product quality, competitive pricing, proper packaging and immediate service and delivery. Working through your CompX Chicago distributor, we offer a program that is committed to serving your needs.

A complete selection of locks

- Door and drawer locks for virtually every application, every security requirement.
- Locking devices of every description for use in schools, institutional and commercial buildings.
- Key blanks and keying kits to complement each of our locks.

Packaged for your convenience

- All hardware is individually packed in see-thru poly-bags for product protection and easy inspection.
- Poly-bags of like hardware are grouped in popular quantities and placed in handy cases.
- Case designed for convenience in storage and ease in handling.
- Cases are labeled for quick identification.



ASSOCIATE MEMBER



ASSOCIATE MEMBER



ASSOCIATE MEMBER

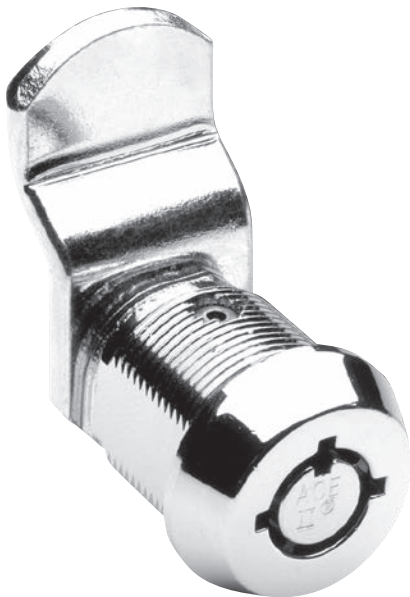

A CUT ABOVE.

The proven Ace II[®] original tubular lock, with its all brass construction and assembly process, provides professional locksmiths and their customers with excellent security at value prices.

HOW CABINET LOCKS ARE USED

DOOR APPLICATION

Bolt or cam at side locks to frame.

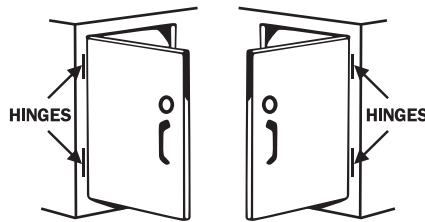

LEFT HAND

RIGHT HAND

At which edge of door hinges are located determines hand of door when facing door.

SINGLE DRAWER APPLICATIONS

Drawer mounted lock – Bolt or cam locks on frame.

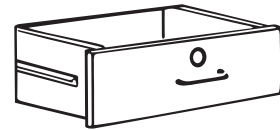

Frame mounted lock – Cam locks on back of drawer front with hook cam engaging strike.

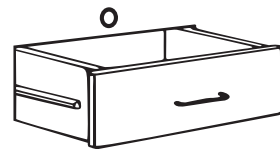

LID APPLICATION

Lock engages strike mounted on underside of lid.

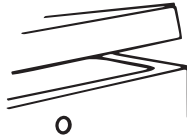

SLIDING (By-pass) DOOR APPLICATION

Lock engages strike mounted on rear door.

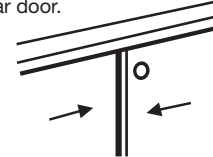

Celebrating 90 years of service to the security industry.

The Family Of...



PO Box 200
Mauldin, SC 29662
Phone: 864-297-6655 Fax: 864-297-9987
E-Mail: national@compX.com
compX.com



715 Center Street
Grayslake, IL 60030
Phone: 847-752-2500 Fax: 847-752-2419
E-Mail: fort@compX.com
compX.com



715 Center Street
Grayslake, IL 60030
Phone: 847-752-2600 Fax: 847.752.2420
E-Mail: timberline@compX.com
compX.com



PO Box 200
Mauldin, SC 29662
Phone: 864-297-6655 Fax: 864-297-9987
E-Mail: chicago@compX.com
compX.com

ACE II® CAM TYPE UNIVERSAL FUNCTION LOCKS

UNIVERSAL FUNCTION ACE II® CAMLOCK

Ideal for Desk Drawers, Cash Drawers, Cabinets and many other applications!

FLEXIBLE & EASY TO INSTALL

- Select the length you need.
- Select the key rotation you want: 90° or 180°, clockwise or counter.
- Reliable security.

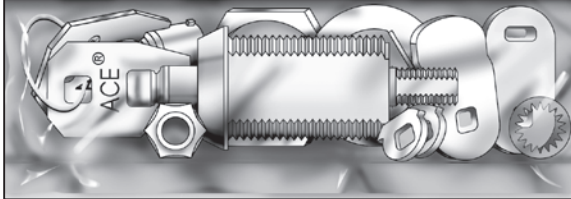

Conveniently Packaged! More Versatile Than Ever!

- **Effective Retail Display**—packages include easy to follow instructions for replacement lock needs.
- **Convenient Field Use**—The Universal Function package includes everything you need for quick, easy installation.
- **All brass construction.**
- Ace II® assembly.
- Center plug contains anti-drill pin for added security.
- Polished Nickel finish.
- Furnished with straight locking cams which can be mounted vertically or horizontally and also a 1/4" offset cam. Cams are 1/8" thick X 3/4" wide.
- Two keys per lock.
- D137-CLC key blank.

Specifications:

KEY ROTATION/REMOVAL is determined by the STOP CAM you select and how it is positioned.

- A. 180° Clockwise Rotation - Key removal at 12 O'Clock.
- B. 180° Counter Clockwise Rotation - Key removal at 12 O'Clock.
- C. 90° Clockwise Rotation - Key removal at 12 & 3 O'Clock.
- D. 90° Counter Clockwise Rotation - Key removal at 12 & 9 O'Clock.

LOCKING CAM (SEE OPTIONS BELOW)

STOP CAM (SEE OPTIONS TO LEFT)

LARGE BODY NUT

ANCHOR WASHER

LOCK CYLINDER

SELF LOCKING HEX NUT

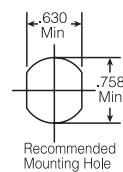
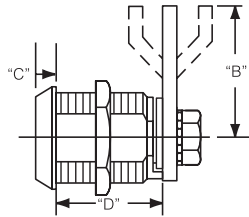
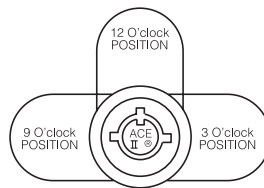

Lock No.	"B" Dim.	"C" Dim.	"D" Dim.	KA Codes	KD Changes	Box Quantity
C4198	1 1/8 28.6mm	23/64 9.04mm	19/32 15.1mm	6224 6225 7302	200	25
C4153	1 1/8 28.6mm	1/4 6.4mm	11/16 17.5mm	6032 6234 7302 7525 PL-505 PL910	200	25
C4152	1 1/8 28.6mm	13/64 5.2mm	15/16 23.8mm	7302 PL-505 PL910	200	25
C4160	1 1/8 28.6mm	13/64 5.2mm	13/32 27.8mm	6234 6502 7302 PL-505	200	25

SLIDING DOOR LOCKS

- Reliable ACE II® cylinder can be keyed compatibly with other ACE II® models
- Solid die cast housing and locking pin
- Retrofits most existing sliding door locks
- Easy cylinder removal for replacement or rekeying
- Available keyed alike, keyed different and keyed in groups
- Bright chrome finish
- Two keys per lock
- D137-CLC key blank

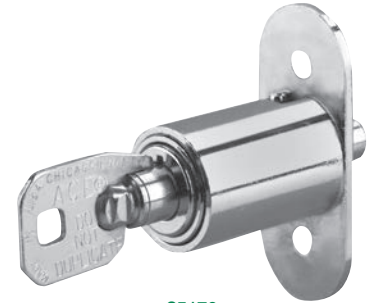
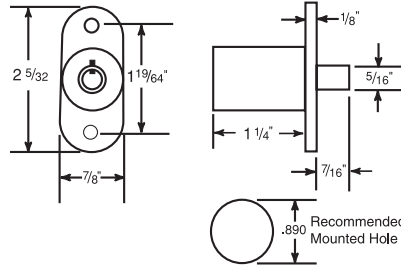

C5170

Lock No.	KA Codes	KD	Box Quantity
C5170	6303 7302	200	10

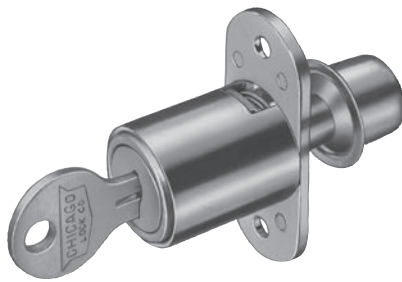

C1770

- Five disc tumbler plug in 7/8" diameter
- Die cast barrel
- C1770 utilizes a spring bolt which locks by pushing the cylinder in and released by turning the key 90° from locked (12 O'Clock) to unlocked (3 O'Clock) position.
- Keypull in locked and unlocked positions
- Satin Chrome finish.
- Mounting plate is 5/64" X 7/8" X 2" with 1 1/2" between mounting hole centers
- Two keys per lock
- DK-5 key blank

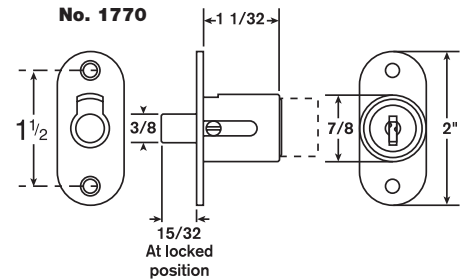

Lock No.	KA Codes	KD Changes	Box Quantity
C1770	1289 1454	200	10

SAMPLE BOARDS

ACE II TUBULAR LOCKS



V69B-19 BOARD

V69B-19 Board displays Ace tubular cam locks, C4153 - C4198, C4235-DC switch lock, C4073 series switch locks, C5170 showcase lock, C4260-19 cylinder lock, C425519RL T-handle Cylinder, CSA4107 screw type lock.

FILE LOCKS, SINGLE AND DOUBLE BITTED LOCKS

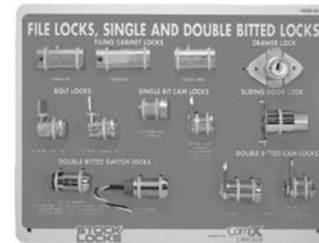

V69B-20 BOARD

V69B-20 Board displays C5001LP, C5002LP & CEXP-19DC file cabinet locks, C1974 & C1975 bolt locks, C17256TNH six tumbler drawer lock, C3786 single bitted cam lock, C1770 single bitted sliding door lock, C1802 & C3186 double bitted cam locks, C2174 series & C3535BDC switch locks, C1968 drawer lock.

SERVICE PARTS KITS

Ace® Factory Original Parts now in Convenient Service Kits for Locksmiths!

Ace® Locking Cam and Tumbler Service Kits from CompX Chicago save invaluable time!

They provide all the parts needed to service locks in one compact container. No more wasted trips back to the shop to find forgotten tumblers, springs... *it's all right at your fingertips.*

Single and Double Bitted Service Kits also available (see page 7).

Contact your local distributor to order and save both time and money!

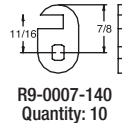
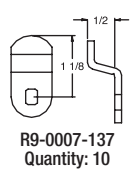
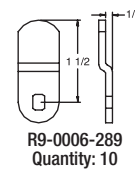
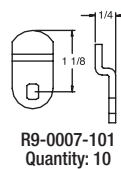
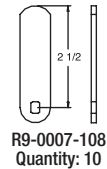
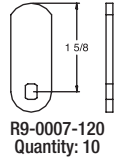
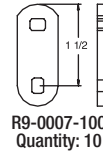
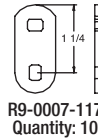
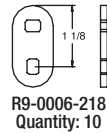

Ace® Locking Cams Service Kit

Part No. *D9629*



Note: Cams are 3/4" wide by 1/8" thick.

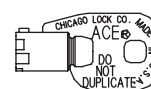
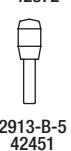
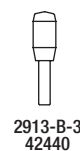
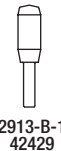

















Ace® Tumbler Service Kit













Part No. *D9630*

Quantity: 200 pieces per compartment, unless otherwise marked



Single Bitted Service Kit - Part No. *D9094*

-  Quantity: 100
-  Quantity: 100
-  Quantity: 100
-  Quantity: 100
-  Quantity: 100
-  Quantity: 100
-  Quantity: 100
-  Quantity: 100
-  Quantity: 100
-  Quantity: 100
-  Quantity: 100
-  Quantity: 300
-  Quantity: 50
-  Quantity: 50
-  Quantity: 10
-  Quantity: 10
-  Quantity: 10

-  Tumbler Assemblies
Standard - 43445
Off Center
Left - 43446
Right - 43443
K4W - 43447
Quantity: 5 each
-  Double Bitted
Tumblers
41098
Quantity: 220
-  Tumbler Springs
40461
Quantity: 20
-  Keyblanks
K4S - 83001
K4L - 83002
K4R - 83003
Quantity: 10 each
-  K4W Keyblanks
83004
Quantity: 10
-  Flat Washer (3/4 I.D.)
41307
Quantity: 10
-  Lock Washer (1/2 I.D.)
27447
Quantity: 10
-  Crescent Spring
37193
Quantity: 50
-  Crescent Ring
37512
Quantity: 50
-  Hex Nut
40174
Quantity: 10
-  Cam Nut
47753
Quantity: 10
-  Retaining Clip
22058
Quantity: 10

Double Bitted Service Kit - Part No. *D9095*

Replacement Parts for Service Kits

Part No.	Description	Std. Pkg.
6-165	Ace Cam	10
7-67	Ace Cam	10
7-45	Ace Cam	10
7-101	Ace Cam	10
7-13	Ace Cam	10
7-192	Ace Cam	10
7-209	Ace Cam	10
7-240	Ace Cam	10
7-50	Ace Cam	10
2059-44	Mounting Washer	25
29-17	Cam Adaptor	25

GUIDE KEY SET

402 Cut Keys

- Numbered from 2001 to 2576, but not in consecutive order. 2400 Series is not included.
- Order item *#D9402*.

KF Series Cut Keys

- Cut Keys for KF series only.

KEYLOC™ / STEELCASE® REPLACEMENT PLUGS



KeyLOC™ – The tamper evident key ring from CompX Chicago.

- Vinyl coated steel cables – the same used in the aircraft industry – resistant to cutting. If cut, cable is non-repairable.
- Cables are available in 3 sizes: 4", 6" and 9" loops. Key ring loops hold 10 to 50 keys.
- Retainer pins fit securely into ACE II® Cylinder nested in lightweight aluminum housing. Tampering of any kind is revealed immediately.
- Security ring clearly warns "DO NOT DUPLICATE."
- Easy 1/4 turn cable installation.
- All units supplied with 2 keys each. Includes security seal.
- Scratch resistant vinyl cover included.

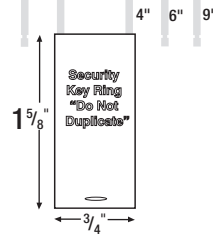

Lock No.	KA Codes	KD Changes	Box Quantity
C4201 4", 6" & 9" Cable Assembly	6201	200	1
C4201-4 4" Cable Assembly	6201 6230 6255	200	5
C4201-6 6" Cable Assembly	6201 6230 6255	200	5
C4201-9 9" Cable Assembly	6201	200	1
C4201-LC Locking Cylinder only	6201 6230 6248 6255	200	1
4201-5A	4" cable only		each
4201-5B	6" cable only		each
4201-5C	9" cable only		each
D137-CLC	ACE II® key blank		50

STEELCASE® REPLACEMENT PLUGS

Take advantage of a tremendous replacement market. Millions of Steelcase desk locks are now in use!



Complete Plug Assembly
P1076-Series

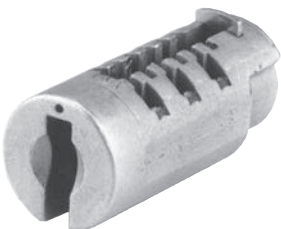

Plug-Sub Assembly
CP1076-Series (Retaining Tumbler Only)

NOW AVAILABLE: FR/XF KEY CODES!

- Direct replacement for Steelcase original equipment
- Loaded plug with two keys; key code stamped on face
- Available in satin nickel finish and black finish

- Retrofits in seconds with the use of the removal tool
- 6 disc tumbler construction easily rekeyable with Service Kit
- Set up your own code systems for each customer with the CP-1076-90

Lock No.	Description	Keyway	KD Changes	Box Quantity
P-1076	Loaded Plug w/2 Keys	K101-K104 (Specify Keyway K101-K104 or our choice)	150	each
CP-1076-90	Un-Loaded Plug (No Keys / Retainer Tumbler only)	K101-K104		each
K-100 RK68	Removal Tool			each

Steelcase is a registered trademark of Steelcase, Inc., Grand Rapids, Michigan.

"T" HANDLE ASSEMBLIES



OU-4260

Handle and Cylinder dimensions do not conform to NAMA dimensional standards.

For Limited Spaces.

- Accepts Ace II® cylinder No. 4260-19. See page 10.
- To use flat key cylinder No. P-1060-19, order "T" Handle No. OU-4260-6T.
- Available with 4260-19 or P-1060-19 cylinders only.
- Chrome finish.
- Supplied with straight cam (B = 1½")

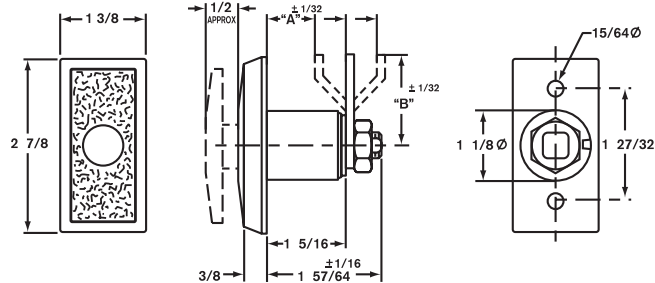

New! 4200 Series.

Retrofits OU-4260 & OU-5560 "T" Handles.

- Increased security for limited spaces.
- Accepts standard & long cylinder locks which meet NAMA dimensional standards.
- Available in ¼ turn, clockwise or counter-clockwise.
- Locking cams can be manufactured per customer requirement, **cam not included.**
- Available 90° or 180° rotation.
- Chrome textured finish for scratch resistance.
- Black finish available. Minimum order may apply.

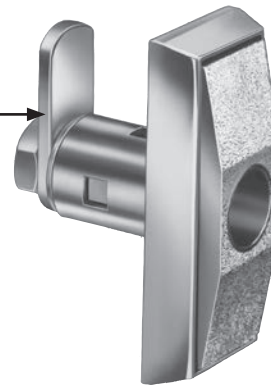

OU-4200-NA

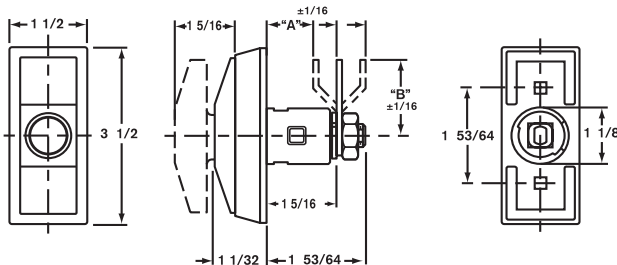

STANDARD SCREW TYPE

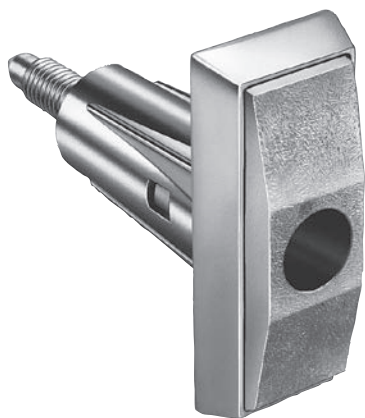

OU-4265-NA

All "T" Handles with suffix NA will accept cylinders which meet NAMA dimensional standards.

Easily Tighten Door Without Losing Seal.

- When fully extended, handle is free wheeling to 360°. When partially depressed, handle is free wheeling to 120°.
- Furnished with ½ x 13 threaded stud.
- Front design has built up flange and tapered "T" Handle construction.
- Accepts standard & long cylinders which meet NAMA dimensional standards.
- Chrome textured finish for scratch resistance.
- Customer must specify "A" Dimension.
- Minimum order may apply for non-standard stud lengths.
- Optional stainless steel handle available.

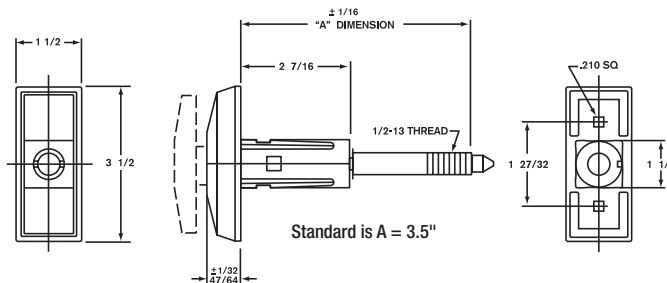

NOTE:
When ordering T-Handles specify all information for proper stud.

"T" HANDLE CYLINDER LOCKS

CYLINDER LOCKS



C425519RL

- 7 Pin tumbler.
- Brass locking bolt.
- Set screw hole for anti-pull feature when used in "T" Handle with set screw feature.
- Chrome finish.
- Thousands of combinations available.
- Two keys per lock.
- **Meets NAMA dimensional standards.**
- Available keyed alike, keyed different, keyed in groups.
- For application options, see page 9.
- D137-CLC key blank

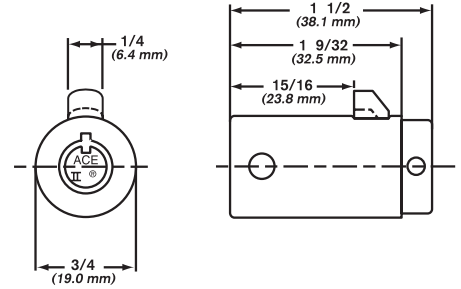

- For use in OU-4260 "T" Handle only. See page 9.
- 7 pin tumbler.
- Brass locking pin.
- Chrome finish.
- Thousands of key combinations available.
- Two keys per lock.
- Available keyed alike, keyed different & keyed in groups.
- D137-CLC key blank

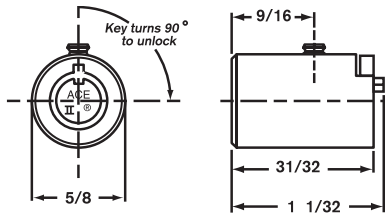

C4260-19

Lock No.	KA Codes	KD Changes	Box Quantity
C425519RL	SP802 SP803 SP804 L463	200	10
C4260-19	L463	200	10



P-1060-19

- For use in OU-4260-6T "T" Handle only. See page 9.
- 6 disc tumblers.
- Over 200 key combinations available.
- Two keys per lock.
- Master keying available at additional cost.
- DK-101-H key blank.

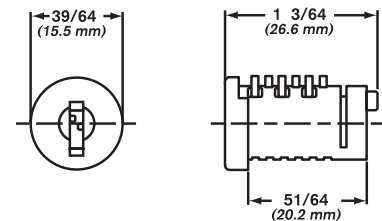

DOUBLE & SINGLE BITTED CAM LOCKS

DOUBLE BITTED

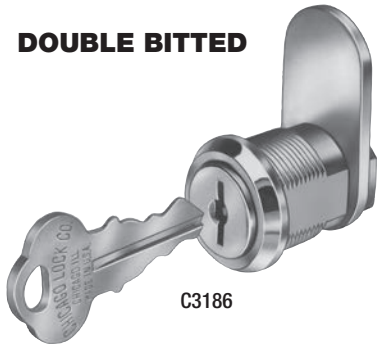

C3186

- Eleven criss-cross blade tumbler plug in $\frac{3}{4}$ " diameter.
- Die cast barrel with two flats — $\frac{5}{8}$ " across.
- Key and cam rotation 90° from locked (12 O'Clock) to unlocked (3 O'Clock) position with keypull in locked position only.
- Straight cam furnished is $\frac{1}{8}$ " thick X $\frac{3}{4}$ " wide.
- Polish Nickel finish.
- Two keys per lock.
- Not available MK.
- DK-45 key blank.

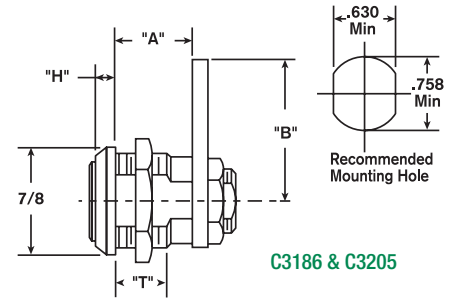

C3186 & C3205

Lock No.	"A" Dim.	"B" Dim.	"H" Dim.	"T" Dim.	KA Codes	KD Changes	Box Quantity
C3205	$\frac{7}{16}$ "	$1\frac{1}{8}$ "	$\frac{13}{64}$ "	$\frac{15}{64}$ "	2001 2007	200	25
C3186	$\frac{5}{8}$ "	$1\frac{1}{8}$ "	$\frac{5}{32}$ "	$\frac{13}{32}$ "	2001 2007	200	25
C1801	$\frac{13}{16}$ "	$1\frac{1}{8}$ "	$\frac{13}{64}$ "	$\frac{11}{16}$ "	2001	—	25
C1802	$1\frac{1}{16}$ "	$1\frac{1}{8}$ "	$\frac{13}{64}$ "	$\frac{15}{16}$ "	2001 2007	—	25
1803 DK-4 keyway only	$\frac{13}{16}$ "	$1\frac{1}{8}$ "	$\frac{13}{64}$ "	$\frac{17}{64}$ "	2141	200	each
C1804	$1\frac{1}{2}$ "	$1\frac{1}{8}$ "	$\frac{13}{64}$ "	$1\frac{13}{32}$ "	2001	—	25

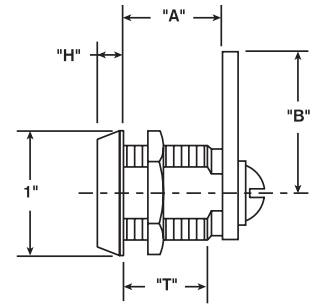

1800 SERIES

SINGLE BITTED



- Five disc tumbler plug in $\frac{3}{4}$ " diameter.
- Die cast barrel with two flats — $\frac{5}{8}$ " across.
- Key and cam rotation 90° from locked (12 O'Clock) to unlocked (3 O'Clock) position with keypull in locked position only.
- Straight cam furnished is $\frac{1}{8}$ " thick X $\frac{3}{4}$ " wide.
- Polish Nickel finish.
- Two keys per lock.
- Available in six disc tumbler.
- DK-5 key blank.

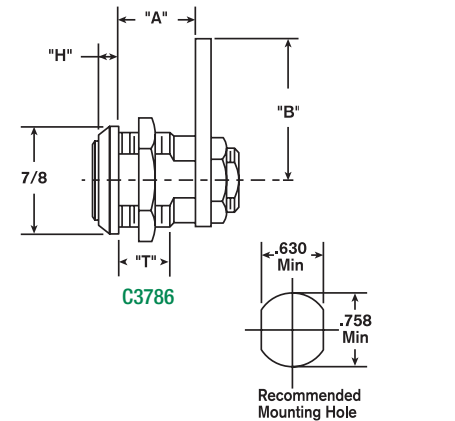

C3786

Recommended Mounting Hole

Lock No.	"A" Dim.	"B" Dim.	"H" Dim.	"T" Dim.	KA Codes	KD Changes	Box Quantity
3705	$\frac{7}{16}$ "	$1\frac{1}{8}$ "	$\frac{1}{4}$ "	$\frac{13}{64}$ "	1289 1454	200	each
C3786	$\frac{5}{8}$ "	$1\frac{1}{8}$ "	$\frac{13}{64}$ "	$\frac{13}{32}$ "	1289 1454	200	25
C1701	$\frac{13}{16}$ "	$1\frac{1}{8}$ "	$\frac{13}{64}$ "	$\frac{11}{16}$ "	1289 1454	200	25
C1702	$1\frac{1}{16}$ "	$1\frac{1}{8}$ "	$\frac{13}{64}$ "	$\frac{15}{16}$ "	1454	200	25
C1703	$\frac{13}{16}$ "	$1\frac{1}{8}$ "	$\frac{13}{64}$ "	$\frac{17}{64}$ "	1289 1454	200	25
C1704	$1\frac{1}{2}$ "	$1\frac{1}{8}$ "	$\frac{13}{64}$ "	$1\frac{13}{32}$ "	1289 1454	200	25

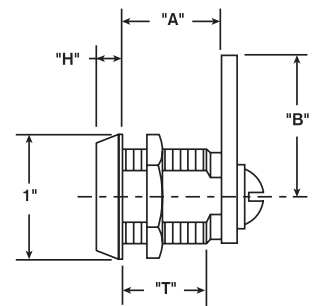

1700 SERIES

CompX Chicago KEYBLANKS

Genuine CompX Chicago key blanks are packed 50 per box.
Order in multiples of 50.



DK-4-L
Off Center Left



DK-4
Center Groove



DK-4-R
Off Center Right



DK-4-W
"W" Milling



DK-2-W
"W" Milling



DK-2
Center Groove



DK-18
Thicker Blank

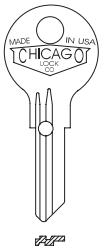

DK-103-G
6-Tumbler

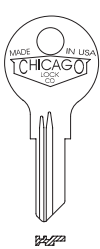

DK-501
5-Tumbler

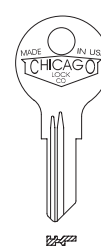

DK-502
5-Tumbler



DK-503
5-Tumbler



DK-504
5-Tumbler

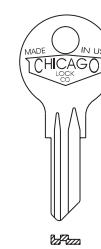

DK-5
5-Tumbler

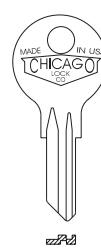

DK-9
5-Tumbler



DK-35
5-Tumbler

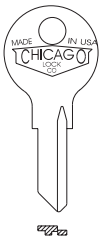

DK-35-M
5-Tumbler



Part number DK-38
(5-Tumbler) is obsolete.
No replacement
parts available.

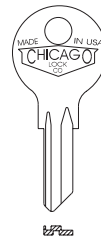

DK-39
5-Tumbler



DK-P-1
4-Pin Tumbler



DK-P-2
4-Pin Tumbler



DK-P-3
4-Pin Tumbler



DK-P-9
4-Pin Tumbler



ACE® & ACE II®
Keyblank
D137-CLC

**GENUINE
CHICAGO
LOCK CO.
KEY BLANKS
DESIGNED FOR
STEELCASE
EQUIPMENT
LOCKS.**

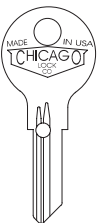

DK-101-H
6-Tumbler

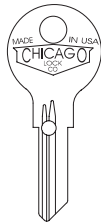

DK-102-H
6-Tumbler

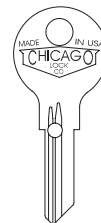

DK-103-H
6-Tumbler

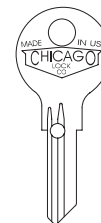

DK-104-H
6-Tumbler

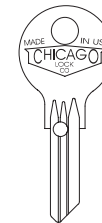

DK-100-MH
6-Tumbler

Steelcase is a registered trademark of Steelcase, Inc., Grand Rapids, Michigan.

PADLOCKS

40MM PADLOCKS / 50MM PADLOCKS



RC-4841



RC-4842

Lock No.	KA Codes	KD Changes	Box Quantity
RC-4841	PL505 7302	200	5
RC-4842	PL505 7302	200	5

40mm Padlock

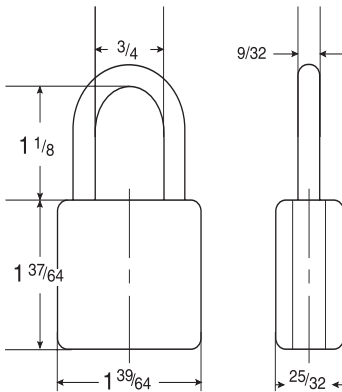

50mm Padlock

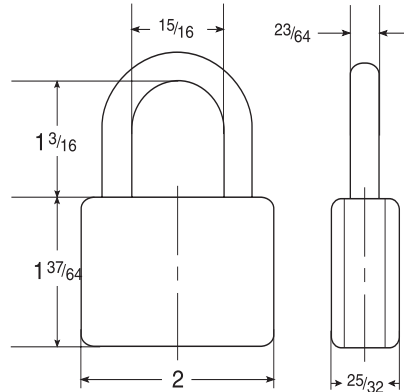

Dimensions shown are without vinyl covers

Our Finest Security Padlock.

- Two sizes available: 40mm and 50mm.
- Removable core and shackle.
- Extruded brass body.
- Hardened steel shackles to resist cutting and sawing.
- ACE II® 7 pin tubular lock with 2 keys.
- Self locking
- Scratch resistant vinyl cover.
- Frequent lubrication is recommended.
- D137-CLC key blank.

How to remove/reinstall cylinder and shackle.

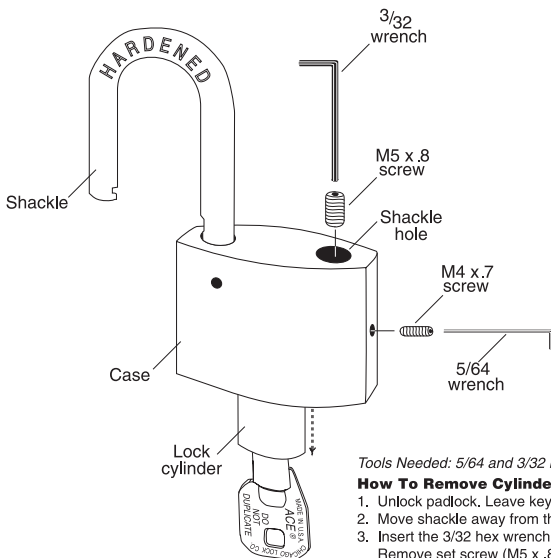

Tools Needed: 5/64 and 3/32 Hex Wrenches.

How To Remove Cylinder

1. Unlock padlock. Leave key in open position.
2. Move shackle away from the case.
3. Insert the 3/32 hex wrench into the shackle hole. Remove set screw (M5 x .8).
4. Insert the 5/64 hex wrench into the hole on the side of the case. Remove cylinder retaining screw (M4 x .7).
5. Hold key and gently pull cylinder out of case. (Save the loose stop washer for reassembly).

How To Reinstall Cylinder

1. Attach stop washer to the end of the lock cylinder.
2. Slide cylinder all the way down into padlock case.
3. Insert cylinder retaining screw (M4 x .7) into side of case. Tighten firmly with 5/64 hex wrench.
4. Insert set screw (M5 x .8) into shackle hole. Tighten firmly with 3/32 hex wrench.

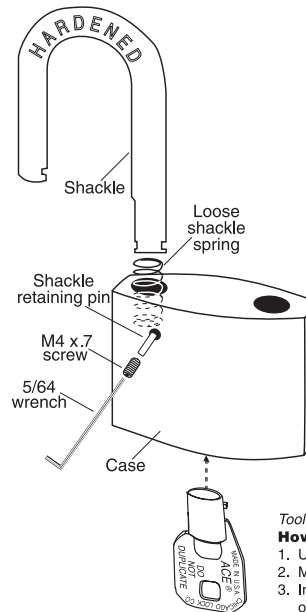

Tool Needed: 5/64 Hex Wrench.

How To Remove Shackle

1. Unlock padlock and remove key.
2. Move shackle away from the case.
3. Insert the 5/64 hex wrench into the hole in the front of the case. Remove set screw (M4 x .7) and the shackle retaining pin.
4. Remove the shackle from the padlock. (Save the loose shackle spring for reassembly).

How To Reinstall Shackle

1. Be sure that shackle spring is in the shackle hole.
2. Insert new shackle and lock the padlock.
3. Insert retaining pin and set screw (M4 x .7) into the hole on front of the case. Tighten firmly with 5/64 hex wrench.

SCREW TYPE / BOLT TYPE LOCKS

ACE II® SEVEN PIN TUMBLER SCREW TYPE



CSA4107

- Ace II® lock assembly in 3/4" diameter.
- Barrel with two flats — 5/8" across.
- 360° key rotation with keypull every 180° (12 and 6 O'Clock).
- Two keys per lock.
- Includes body nut.
- Additional stud lengths available to special order. Minimum order and extended lead time may apply.
- D137-CLC key blank.

Lock No.	"A" Dim.	KA Codes	KD Changes	Box Quantity
CSA4107	7 1/32"	7341	200	10

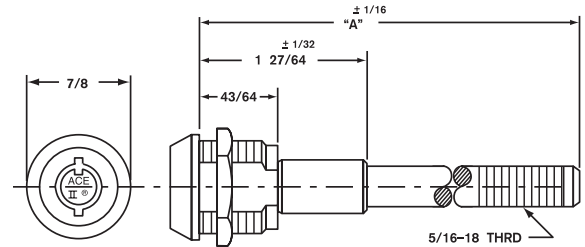

BOLT TYPE

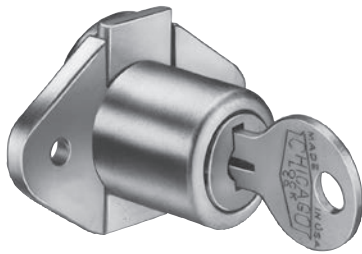

C1968

- Five disc tumbler.
- Removable plug feature.
- Steel locking bolt.
- Two keys per lock.
- DK-5 key blank.

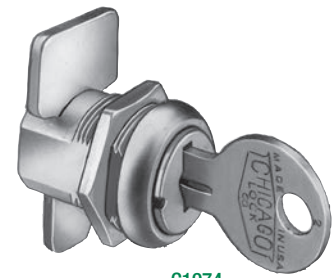

C1974

Lock No.	"A" Dim.	"D" Dim.	KA Codes	KD Changes	Box Quantity
C1968	57/64" 22.6mm	15/32" 29.6mm	1289 1454	200	25
C1974	19/32" 15.1mm	27/32" 21.4mm	1289 1454	200	25
C1975	21/32" 16.7mm	57/64" 22.6mm	1289 1454	200	25

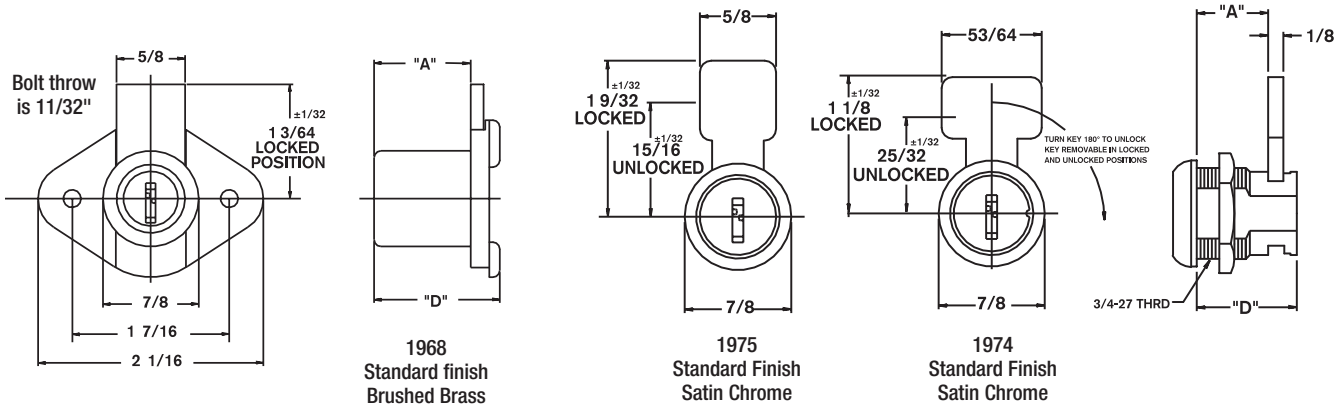

1968
Standard finish
Brushed Brass

1975
Standard Finish
Satin Chrome

1974
Standard Finish
Satin Chrome

SWITCH LOCKS

SINGLE POLE, SINGLE THROW

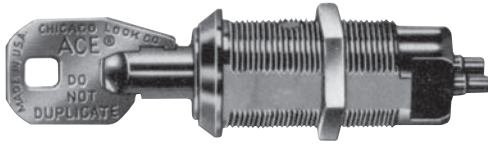

C4073 SERIES

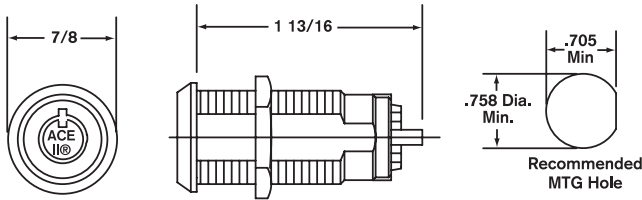

Ace II® Lock Assembly.

- Maintaining contact switch operated by manually rotating inserted key 90° clockwise from open to closed position.
- Momentary contact switch locks feature spring return from closed to open position after 90° clockwise key rotation to closed position.
- Contact configuration: SPST
- 7 amps @ 28 VAC/VDC
- Electrical Life: 6,000 cycles @ Max. Load.
- Contact Resistance: 50 milli ohms initial maximum.
- Bright Chrome finish.
- Two keys per lock.
- Master - Keying not available.
- D137-CLC key blank.

Lock No.	Keypull	Contact	KA Codes	KD Changes	Box Quantity
C4073-1DC	OFF Only	Maintaining	PL927	200	10
C4073-2DC	OFF & ON	Maintaining	PL910	200	10
C4073-70DC	OFF Only	Momentary	PL927	200	10

Warning: Improper connection to circuitry may result in shock. Since CompX Chicago does not control the use of its products, external wiring, switch lock selection, and/or use is not the responsibility of CompX Security Products.

SINGLE POLE, SINGLE THROW



C2174 SERIES

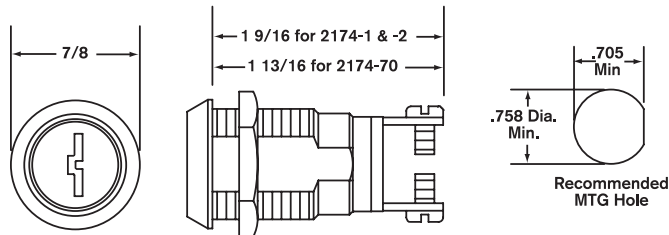

Double Bitted Assembly With Eleven Criss-Cross Blade Tumblers.

- Lock operation same as 4073 Series.
- Contact configuration: SPST
- 7 amps @ 28 VAC/VDC
- Electrical Life: 6,000 cycles @ Max. Load.
- Contact Resistance: 50 milli ohms initial maximum.
- Bright Chrome Finish.
- Two keys per lock.
- Master - Keying not available.
- DK-4 key blank.

Lock No.	Keypull	Contact	KA Codes	KD Changes	Box Quantity
C2174-1DC	OFF Only	Maintaining	2001 2007	200	10
C2174-2DC	OFF & ON	Maintaining	2001 2007 2387	200	10
C2174-70DC	OFF Only	Momentary	2001 2007 2126	200	10

Warning: Improper connection to circuitry may result in shock. Since CompX Chicago does not control the use of its products, external wiring, switch lock selection, and/or use is not the responsibility of CompX Security Products.

SWITCH LOCKS

SINGLE POLE, DOUBLE THROW

4235 Series:
Ace II® Lock Assembly.

3535 Series:
Double Bitted Assembly With Eleven Criss-Cross Blade Tumblers.

These features apply to both switch locks:

- 7 amps resistive/4 amps inductive @ 115 VAC or 28 VDC.
- Reliable snap action switch provides many thousands of electrical contacts without failure.
- Terminals designed to accept "AMP" .058 pin receptacles.
- Bright Chrome finish.
- Furnished with 10 inch, 20 gage stranded wire.
- Two keys per lock.
- Master - Keying not available.
- Maintaining only.
- **Switches are U.L. recognized & CSA listed.**
- D137-CLC key blank for tubular.
- DK-4 key blank for double bit lock.

Contact factory for additional specifications.

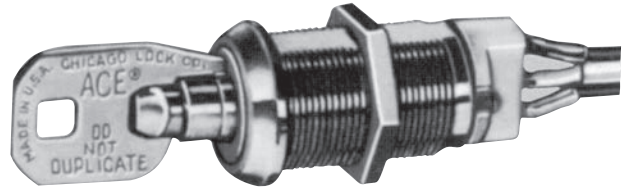

C4235 SERIES



C3535 SERIES

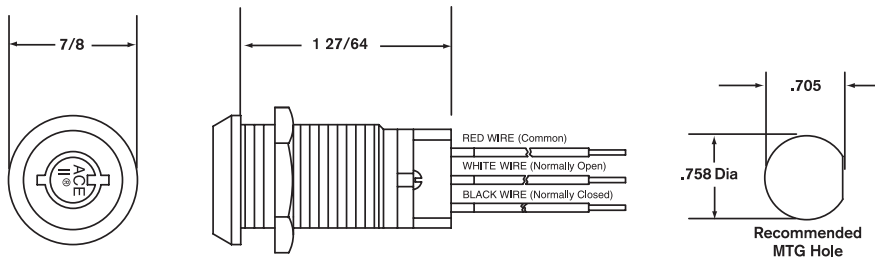

Ace II® Switch Locks — SPDT

Lock No.	Keypull	Rotation	KA Codes	KD Changes	Box Quantity
C4235-DC	2 positions	180° CW	CLC705	200	10
4235BDC	1 position	165° CW	CLC706	200	each

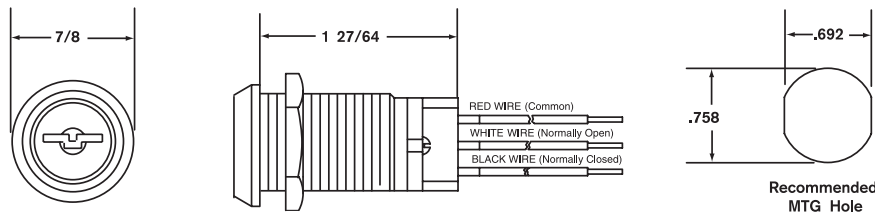

Double Bitted Switch Locks — SPDT

Lock No.	Keypull	Rotation	KA Codes	KD Changes	Box Quantity
3535DDC	2 positions	180° CW	2387	200	each
C3535-BDC	1 position	165° CW	2382	200	10

Warning: Improper connection to circuitry may result in shock. Since CompX Chicago does not control the use of its products, external wiring, switch lock selection, and/or use is not the responsibility of CompX Security Products.

SPECIAL PURPOSE LOCKS

DRAWER & DOOR

- Six disc tumbler plug in $\frac{3}{4}$ " diameter.
- Die cast barrel with two flats — $\frac{21}{32}$ " across.
- Key and cam rotation 90° from locked (12 O'Clock) to unlocked (3 O'Clock) position with keypull in both positions.
- This lock designed to be used with customer's latching mechanism.
- Satin Nickel finish.
- Two keys per lock.
- DK-101-H key blank.

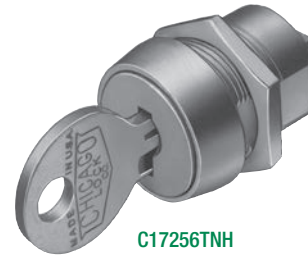

C17256TNH

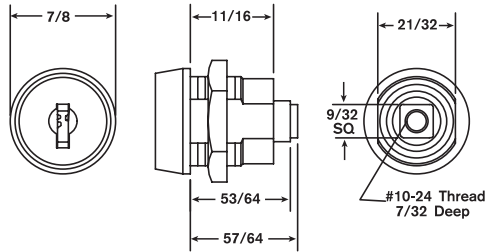

Lock No.	KA Codes	KD Changes	Box Quantity
C17256TNH	1101X	150	25

FILING CABINET

CEXP-19DC

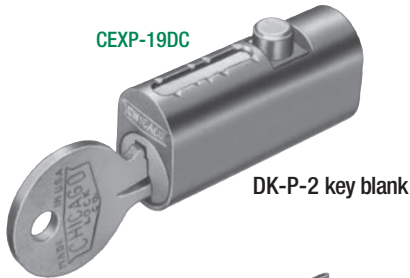

DK-P-2 key blank

- Four pin tumbler plug.
- Die cast barrel with die cast bolt.
- 5002LP has rectangular bolt.
- Other models have round bolt.
- Satin Chrome finish.
- Two keys per lock.

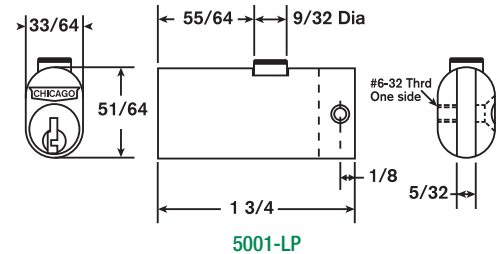

5001-LP

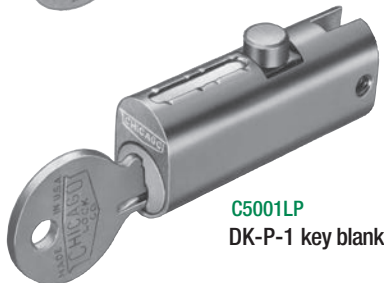

C5001LP
DK-P-1 key blank

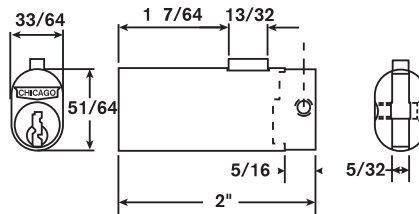

5002-LP
DK-P-1 key blank

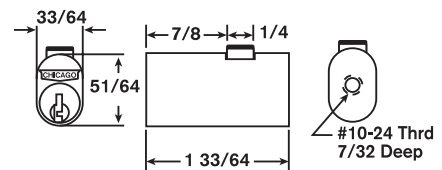

EXP-19DC

Lock No.	"A" Dim.	"Bolt" Dim.	"D" Dim.	"O.A." Dim.	"W" Dim.	KA Codes	KD Changes	Box Quantity
C5001LP	$\frac{55}{64}$ "	$\frac{9}{32}$ " dia.	$\frac{5}{16}$ "	$1\frac{3}{4}$ "	$\frac{5}{32}$ "	1X03 3X5 1X04 2X01	200	10
C5002LP*	$\frac{17}{64}$ "	$\frac{27}{64}$ " x $\frac{9}{64}$ "	$\frac{5}{16}$ "	2"	$\frac{5}{32}$ "	1X20 2X02	200	10
CEXP-19DC	$\frac{7}{8}$ "	$\frac{1}{4}$ " dia.	NA	$1\frac{33}{64}$ "	NA	5X75	200	10

* To order replacement locks for Steelcase equipment, specify 5002LP, KA# CL-S100.

Steelcase is a registered trademark of Steelcase, Inc., Grand Rapids, Michigan.



NOTES:

ACE KEY COVERS / WEATHER COVERS

ACE® KEY COVERS



Available in a large range of colors, these user friendly Ace II® Key Handle Covers from CompX Chicago make key management easy.

Key Handle Covers are made of a durable, strong plastic that press-fit any ACE II® key. The larger size allows for better grip and overall control of the key.

Product No. Specified By Color (Sold in packages of five.)

Available in the following colors:

Light Blue D9645	Purple D9651	Yellow D9646	Tan D9652	Blue D9650
Green D9648	Brown D9654	White D9649	Orange D9647	Rust D9653

WEATHER COVERS

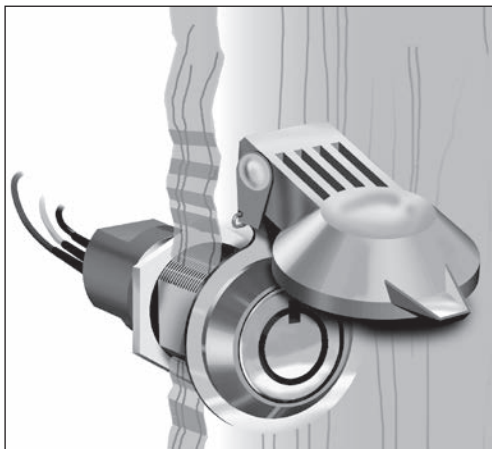

Dust Cap No. D9655-WC (Sold in packages of five.)

Protect Switch Locks and Cam Locks from the elements with this economical, easy to install weather cover.

Quality construction includes:

- Chrome plated zinc die cast cover.
- Stainless Steel mounting ring.
- Permanently installed rubber seal.
- Positive spring closure to ensure seal integrity.
- Inside dimension: .755"

Competitively priced, and in stock for immediate shipment.

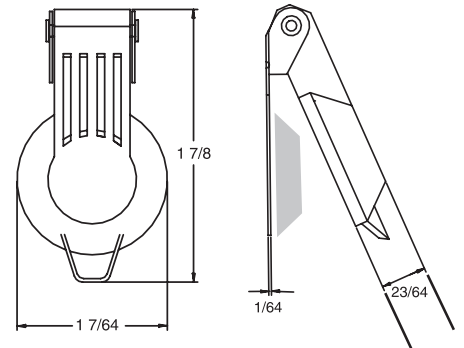

SPECIALTY STRIKE

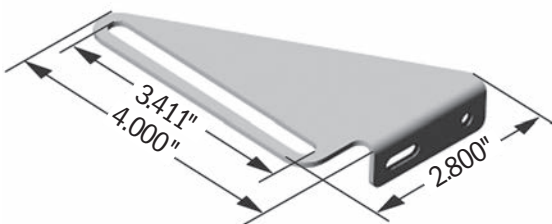

Lock No.	Description	Box Quantity
C500SP	Designed to lock file and box drawers when no other locking points are available.	25



MAIN OFFICE - FACTORY

REGISTERED TO ISO 9001
CERTIFICATE NO. 10000456

PO Box 200
Mauldin, SC 29662
PH: 864-297-6655
FAX: 864-297-9987
compX.com

WESTERN DISTRIBUTION CENTER

9370 Buffalo Avenue, Unit 104
Rancho Cucamonga, CA 91730
PH: 909-476-7933
FAX: 909-476-8553

Reorder #: F2644-002
November 2017
Printed in the USA

Copyright 2017
© CompX Security Products



COMPX NATIONAL
REGISTERED TO ISO 9001
CERTIFICATE NO. 10000456

